

Southern PRIDE

WOOD BURNING BBQ PITS & SMOKERS

MODEL DH-65

(2009 and Newer)

INSTRUCTION MANUAL



Southern PRIDE

WOOD BURNING BBQ PITS & SMOKERS

472 South Mill Street Alamo, TN 38001

PHONE: 800-851-8180 FAX: 731-696-3180

www.southern-pride.com sales@sopride.com service@sopride.com

SERVICE: 800-437-2679 SERVICE FAX: 618-993-0378 parts@sopride.com

*** CONGRATULATIONS ***

In selecting **SOUTHERN PRIDE**, you have chosen the finest, most advanced, and fully automatic smoker / steamer oven available. With us, "It's A Matter Of Pride".

Please read this INSTRUCTION MANUAL carefully prior to installation and operation. Proper installation, use, and cleaning are essential for your satisfaction and safe operation.

KEEP THIS MANUAL FOR REFERENCE

TABLE OF CONTENTS

	Page
Safety Information	2
Oven Controls & Features	3
Operating Instructions	5
How To Run A Menu	6
Digital Controler Programing	7
Cleaning Instructions	9
Installation Instructions	10
Electrical Instructions	11
DH-65 Wiring Diagram	12
Parts List	13
Warranty	16

SAFETY INFORMATION

1. Be sure all untrained employees, who may operate this oven, are instructed on the proper operation and safety information prior to working with this oven.
2. Oven surfaces are HOT when oven is in operation. Proper utensils and protective gear should be used with this appliance.
3. Oven cleaners can be HAZARDOUS. Read and follow all labeled instructions.
4. The frame of the oven MUST be electrically grounded at all times. See “Electrical instructions” in this manual.

WARNING:

FAILURE TO GROUND THIS UNIT MAY RESULT IN AN ELECTRICAL SHOCK.

5. Do not remove the service compartment access panel unless power to the oven is OFF.
6. Do not allow unqualified personnel to perform service work. To do so will VOID WARRANTY and could be hazardous.
7. CAUTION: Ashes removed from ovens equipped with smoker should be extinguished immediately with water.
8. Daily cleaning is extremely important to insure FIRE SAFETY and FOOD SAFETY.

OVEN CONTROLS & FEATURES

1. **Digital Roast & Hold Control** - Programmable (325 degrees F) with off position. Maintains the desired oven temperature by controlling the main heat element.
2. **Control Panel Cover** - Houses the convection fan motor and electrical components.
3. **Flue** - Exhaust flue must be installed under an approved vent hood system.
4. **Food Racks** - The DH-65 comes standard with 5 - 18" x 26" x 2 1/2" nickel chrome plated wire rib racks that slide out for easy loading and unloading of product. Flat racks are available as an option.
5. **Side Channels** - Acts as an air channel to direct air flow in the oven, and has the slides for the food racks. Easily removable for cleaning.
6. **Smoker Chip Box** - Load with wood chips to smoke product. To fill or empty the box, slide it off of the element bracket.
7. **Smoker Element** - Slide smoker chip box completely over smoker element to insure complete burning of wood chips.
8. **Steam Water Pan** - Make sure water pan is seated on steamer element holder and filled to the indicator line before using.
9. **Steam Diverter** - Sets on top of the steam pan lip to guide steam outward in oven for more even steam distribution and keeps cool meat juices from cooling down steam water.
10. **Drip Pan** - Slides out on rails located under the oven, should be emptied after each cooking.
11. **Casters** - For ease of moving the oven, the front casters are locking.
12. **Blower Wheel & Fan Shroud** - Main element and blower wheel cover can be removed for cleaning.
13. **Blower Wheel** - Blower wheel located behind the fan shroud, circulates heat and smoke inside the oven.

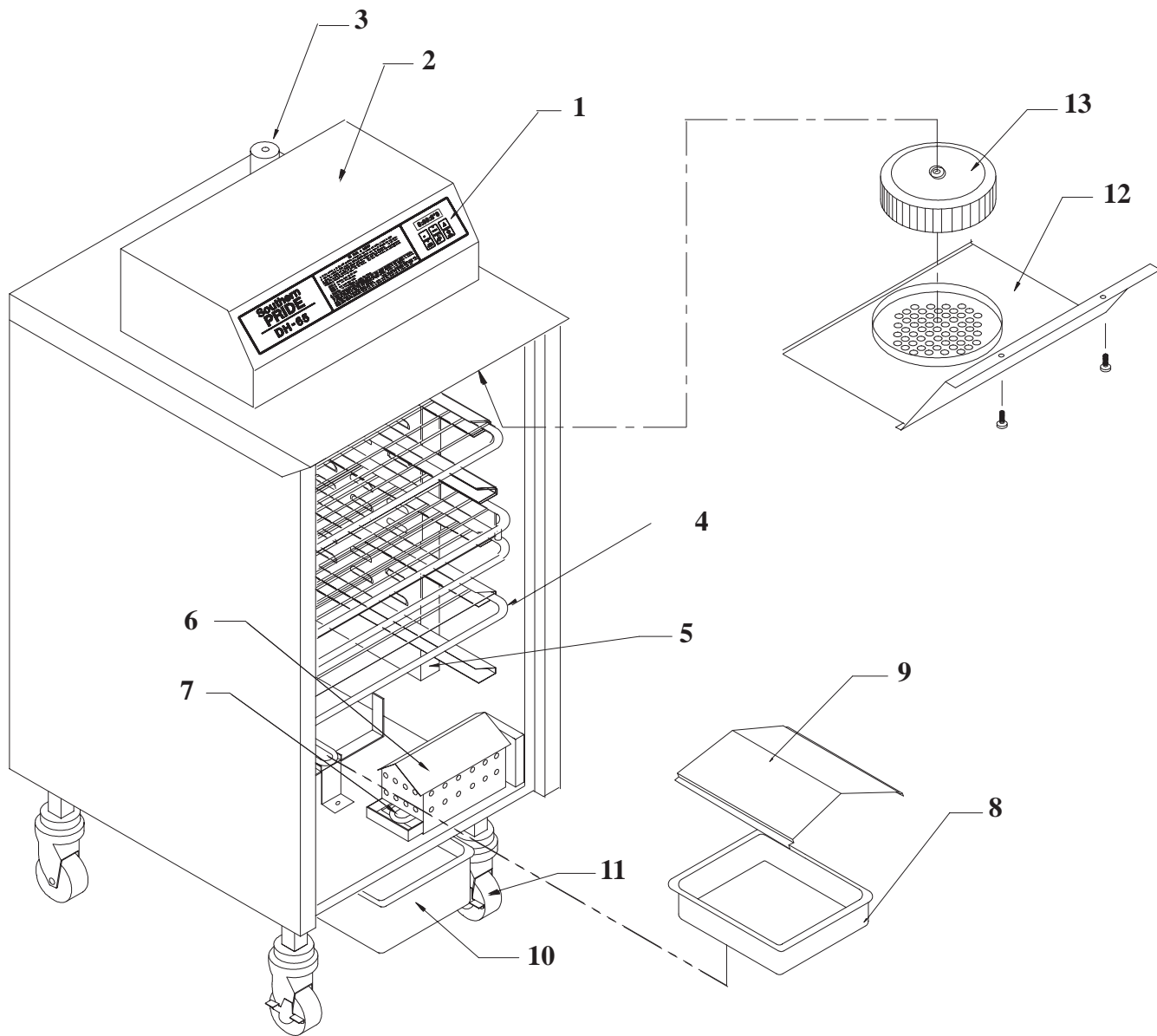

OPERATING INSTRUCTIONS

1. Remove the bottom two racks from the DH-65.



2. Lift the steam diverter from over the steam pan located in the bottom of the oven.

3. Fill the steam pan with water to the level shown.
Note the stamped fill water line in the corners of the pan. Replace the steam diverter

Stamped
Line



4. Next remove the chip box by sliding it off the element support . Fill the chip box with chips and place it back over support bracket. Make sure the lid is closed and slide the chip box all the way to the right under the drip edge.

Drip Edge

5. Season and load up to 65 slabs of ribs in the rib racks. Ribs and other products may also be cooked on the optional flat racks.
6. Close and LATCH the door. Refer to HOW TO RUN A MENU on page 7..

HOW TO RUN A MENU

1. If the control is in the off position, a touch to any button will bring it back to IDLE.
2. With the control in IDLE. Press the MENU SELECT button one time to display the set menu. The led display should read 1.
3. Press the ARROW UP or ARROW DOWN button until the desired menu is displayed. (The DH-65 comes with the first four menus preprogrammed into the control.)
 - Menu 1 - is for cooking 1-15 slabs of ribs at 325°
 - Menu 2 - is for cooking 15 - 40 slabs of ribs at 325°
 - Menu 3 - is for cooking a full loard of ribs at 325°
 - Menu 4 - is for a 4 1/2 hour slow cook menu at 225°

There can be 40 menus stored in the controler memory.

4. Press the START/STOP button to bring the selected menu cook cycle. An audible alarm will sound at the end of the cook cycle..

NOTE: If possible **DO NOT OPEN** the door until the cook cycle is complete. If you must open the door before the cycle is complete, **USE CAUTION BECAUSE HOT STEAM WILL ESCAPE.** Open the door slightly and slowly to allow the steam to escape before opening the door fully to unload the product.

5. To PAUSE the cook cycle press the START/STOP button one time. Press it again to resume the cook.
6. To STOP the cook cycle press and hold the START/STOP button. The controller will return to IDLE.
7. A menu must be programmed with a Set Time before it can be run.

NOTE: This oven is designed to steam, therefore **DO NOT OPERATE THE DH-65 UNLESS** the steam pan support, steam pan and the steam diverter are in place. The **DH-65 STEAM PAN MUST BE FILLED WITH WATER BEFORE COOKING.** Using the wood chip box is optional.

TO PROGRAM A MENU

1. Press and hold the Up Down buttons simultaneously for 30 sec.



will appear in the LED.



2. Press the arrow Up or Down button until the desired menu is displayed. There can be 40 programmed menus stored on the controller.



3. To change the menu settings press the Edit button one time.

The display will flash alternately between StPt 1 and the temperature setting of StPt 1.



4. To change the set temp. press the Edit button again. Press the Up or Down button to select the desired cook temp. Press the Enter button one time to save the setting.

5. The controller will again flash alternately between Step 1 and the set temperature setting.



6. Press the arrow Down button. The display will then flash alternately between time 1 and the set time for step 1.

7. To change the time 1 setting, Press the Edit button one time and the set time for step 1 will be displayed in the LED.



8. Press the Up or Down arrow to set the desired cook time for step 1.



9. Press the Enter button one time to save the desired cook time for step 1.



10. Most menus will have two set times set in a menu, the controller will flash alternately between Time 1 and the set time of Time 1.

11. Press the Arrow Down button one time. The controller will flash alternately between Time 2 and the set time of Time 2.



12. To change the set time of Time 2, press the Edit button one time. the controller will display the set time of Time 2. Press the Up or Down arrow to change the set time to the desired time.

13. Press the Enter button one time to save the set time of Time 2. Press the Enter button two times to exit Setup and return to Idle.



14. Follow this same procedure to program as many as 40 menus.

Note: A menu must have a set time programmed in it in order for it to run.

Note: Total cooking time is the combined time of Time1 and Time 2.

CLEANING INSTRUCTIONS

Oven should be cleaned daily to remove any grease or carbon deposits. Poor cleaning habits can be both a food and fire hazard.

Mild dish detergents will remove most of the grease on all the surfaces of the oven. For areas with build up that cannot be removed with soapy water, use conventional oven cleaners.

CAUTION: Always wear protective clothing and eyewear when using oven cleaners. Read labeled directions and warnings.

NOTE: The area above heating element cover on top of the inside can be cleaned by removing the front element cover. Remove the two (2) 5/16 bolts. Let the front drop down and then pull straight out to remove. After cleaning, **COVER MUST BE INSTALLED BEFORE OPERATING OVEN.**

Clean the outside of the oven with commercial stainless steel cleaners and polishes. **NEVER** use any abrasive scrub pads on the outside of the oven.

The steam element/pan support can be easily removed for cleaning. Remove the drain pan to access the nut holding the mounting bolt for the steam pan support. Remove the bolt and the support bracket can be slid out for cleaning.



INSTALLATION INSTRUCTIONS

1. Read and follow the electrical requirements on the page 12 to insure proper connection of the oven.
2. While this oven is in operation it will emit steam and smoke from the vent stack or from the meat door opening if it is opened. Adequate space should be allowed for this oven under a hood to insure that the hood will capture the smoke.
3. Venting for the DH-65 must be with an exhaust ventilation system in accordance with the National Fire Protection Association standard, NFPA 96. Local codes may supercede this recommendation. Check local building codes prior to installation.

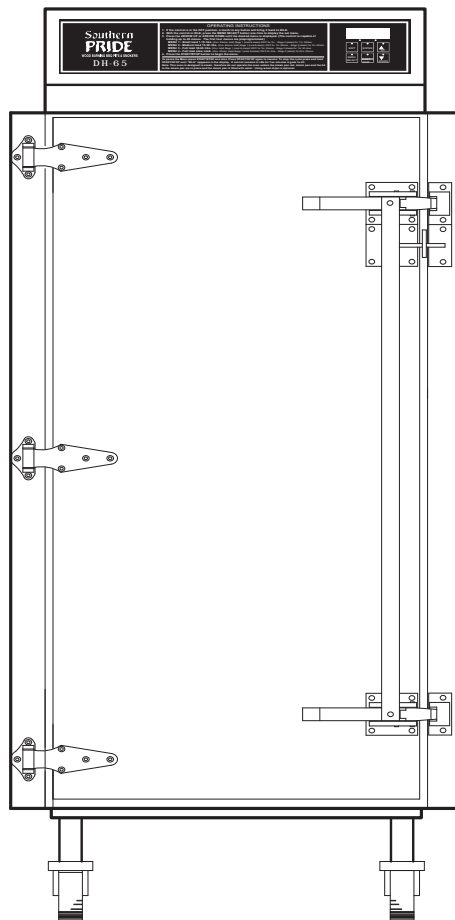

ELECTRICAL

120/208 Volts AC or
120/240 Volts AC
60 Hz
Single Phase
30 AMP wiring required

NOTE: MAKE SURE THE SUPPLY
POWER CORRESPONDS WITH
VOLTAGE SPECIFIED ON THE
NAMEPLATE.

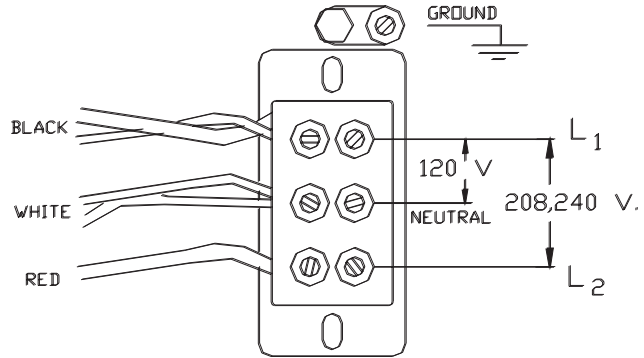

WARNING:

CHASSIS MUST BE GROUNDED TO PREVENT POSSIBLE SHOCK HAZARD.

WARRANTY IS VOID IF THE OVEN IS CONNECTED TO ANY VOLTAGE
OTHER THAN SPECIFIED ABOVE.







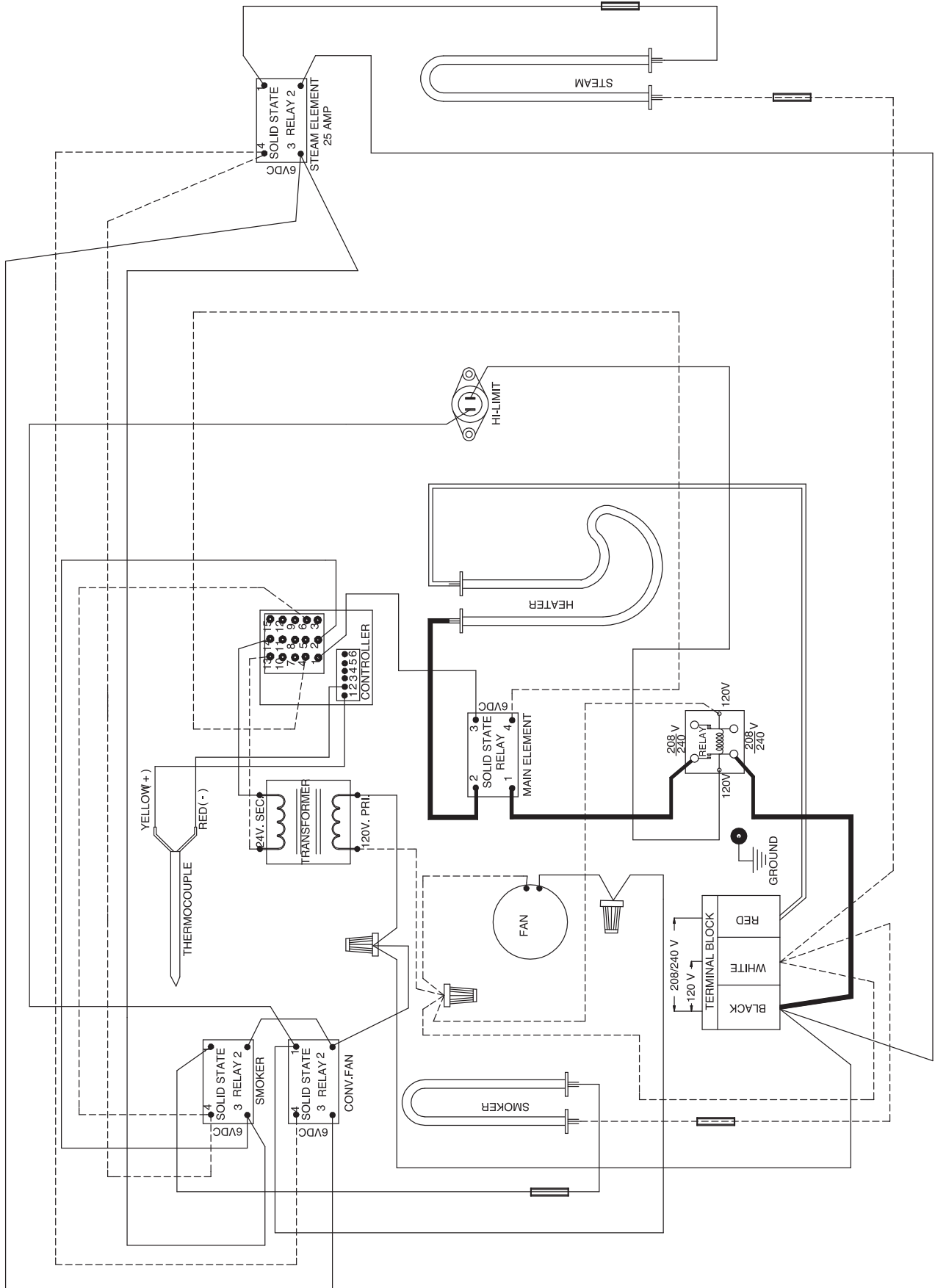

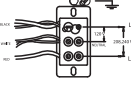
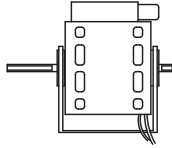

ELECTRICAL INSTRUCTIONS

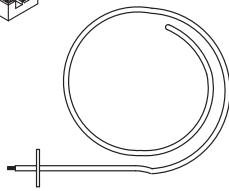
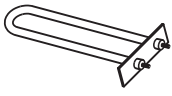
1. This Appliance is not equipped with a power cord from the factory.
2. Power supply connections should be made with flexible conduit. Use a No. 12 AWG wire suitable for at least 90° C.
3. Adequate means must be provided to limit the movement of this Appliance without depending on or transmitting stress to the flexible conduit. A tethering kit is provided with this Appliance that meets these requirements. This kit also contains installation instructions.
4. Power must be OFF at the breaker during installation of the power connections.
5. Electrical service is provided to the oven at the main terminal block located behind the access panel in the lower rear left corner of the oven.
6. Before connecting power verify the correct voltage.
7. Once correct voltage is verified, replace access panel.
8. Attach tether cable to the oven and the wall that the outlet is located on.

DH-65 WIRING DIAGRAM

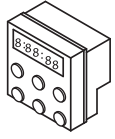
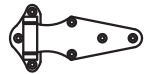

PARTS LIST

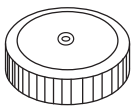
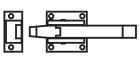
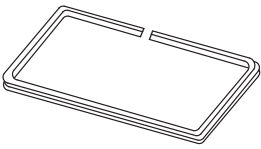
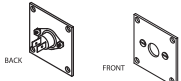
- 1010 Terminal Block 
- 1040SC Convection Fan Motor 
- 1045 Contactor, For Main Element 
- 1046 240 Volt Main Heating Element 
- 1046-1 208 Volt Main Heating Element
- 1049 300 Watt Smoker Element 
- 1065 25 AMP SSR Steamer Relay 
- 1066 Steamer Element 
- 1091 40 AMP SSR Main Element Relay 
- 1092 10 AMP SSR Smoker/Convection Relays 
- 1093 Temperature Probe 
- 1098 S.S. Thermocouple For Digital Control 
- 1090-DH65 100-325 Degree Digital Control 
- 2116 Door Hinge 
- 2417 6" Cooling Fan Blade 
- 2422S Blower Wheel 
- 2438 Door Latch And Catch 
- 4179G Meat Door Gasket 
- 9172 340 Degree High Limit Switch Assembly 

1240 Smoke Element Gasket 

1241 Steam Element Gasket 

1242 Smoke Element Support Gasket 

7183 Main Element Gasket 

2425-6 Drain pan 

9920 Steam Pan Cover 

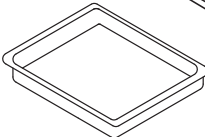
2425 Steam Pan 

9949 Steam Pan Support Bracket 

1059 Transformer 

1245 Food Rack 

9830 Wood Chip Box 

**ONE YEAR LIMITED WARRANTY
(CONSULT FACTORY FOR DETAILS)
90 DAY LABOR WARRANTY (PRE AUTHORIZED)**

Southern Pride guarantees all new equipment of its manufacture to be free of defects in material and factory workmanship for a period of one year provided that the equipment is installed in the Continental United States, Alaska, or Hawaii and operated according to the Owner's Manual while located at the original address of installation, the warranty registration card has been completed and returned to the factory within fifteen (15) days after installation and a start-up has been preformed by an authorized service agent.

Southern Pride's obligation under this warranty is limited to one of the following options with the option applicable to be selected by Southern Pride at the sole discretion of Southern Pride.

1. Owner to return part, freight PREPAID. Southern Pride is to repair at own expense if defective, and ship part back to owner freight collect.
2. Southern Pride to furnish replacement part, freight collect, without requesting return of the defective part.
3. Southern Pride to furnish replacement part, freight collect, in exchange for return of the defective part, freight collect.

Under certain circumstances Southern Pride will reimburse owner for limited labor costs in replacing parts during a period of not more than ninety (90) days after installation, **(provided that work is prior authorized and confirmed by Southern Pride's Service Manager.)**

Because Southern Pride does not and cannot control the owner's installation, use and maintenance of equipment manufactured by Southern Pride, this warranty does not cover: any equipment installed improperly; any equipment calibrated after start-up and acceptance; any component disassembled in the field; damaged due to improper cleaning, i.e. burner (hosing or "watering down" machines will cause electrical failures not covered by warranty); blown fuses, light bulbs, gaskets, electric elements and accessory components not installed or manufactured by Southern Pride. Shipping damage must be reported to the carrier and is not covered under this warranty.

Southern Pride will not be liable for damage as a result of improper installation, misuse, abuse, alteration of original design, incorrect voltage, **unauthorized service**, or breakage of fragile items, Southern Pride will not be liable for any loss or consequential damage or expense accruing directly or indirectly from the use of equipment covered by this warranty including any production or product losses or other damages which may occur as a result of equipment malfunction or failure. This warranty does not cover cooking performance, which is a function of food types, textures, temperatures and other variables chosen by the owner and over which Southern Pride has no control. The effect of corrosion, fire and normal wear on the equipment or component parts is not covered by this warranty. This warranty does not apply to damage caused by accident or to damage caused by the negligence of the owner and the employees of the owner or to damage caused by lightning generated electrical current or any other Act of God whatsoever. This warranty does not apply to any equipment bearing a serial number which has been tampered with or altered.

This warranty is exclusive and is in lieu of all other warranties, express or implied, including any implied warranty or merchantability or fitness for particular purpose, each of which is hereby expressly disclaimed, the remedies described above are exclusive and in no event shall Southern Pride be liable for special, consequential or incidental damages for the breach or delay in performance of warranty.

TERMS AND CONDITIONS

For purposes of definition and interpretation, the term "Seller" as used herein refers to Southern Pride and the term "Buyer" refers to the originator of a specific purchase order to Southern Pride.

Possession of a price list does not necessarily constitute an offer to sell by Southern Pride. Prices and specifications are subject to change without notice. All items will be invoiced at prices in effect at time of shipment. Equipment prices do not include federal, state, city or local taxes which may apply and all sales are subject thereto. No order, whether written or oral, shall result in a contract, unless it is accepted and acknowledged in writing by Seller at Seller's office in Alamo, TN.

Shipping weights are approximate and all prices are quoted F.O.B. Alamo, TN. All "common carrier" shipped equipment shall be domestic crated; all others shall be uncrated and subject to delivery charge per zone chart. Any equipment held for shipment upon Buyer's request beyond the delivery date specified on original purchase order will be due and payable within terms and will result in storage charges.

Delivery estimates are figured from date written orders are received and accepted by Seller. Seller will meet Buyer's delivery request as nearly as possible, but does not guarantee shipment nor delivery on any particular date. Seller reserves right to ship merchandise via any responsible carrier. Seller's responsibility ceases upon acceptance by carrier. Buyer is expected to examine contents of shipments and immediately report any damage to carrier authorities.

Payment terms shall be 30% deposit with order; balance prior to delivery unless otherwise agreed in writing by Seller. Returns of any merchandise may not be made without Seller's written approval, prior to return. Seller shall impose a 20% restocking charge for handling of any returns. All cancellations must be in writing. Cancellations are also subject to a 20% fee.