

# Southern PRIDE

WOOD BURNING BBQ PITS & SMOKERS

## MODELS SC-100 & SC-200

(all SC-100, SC-200 before 2007)

### OWNERS INSTRUCTION MANUAL



**Southern  
PRIDE**  
WOOD BURNING BBQ PITS & SMOKERS

5003 Meadowland Pky. - MARION, ILLINOIS 62959

PHONE: 618-997-9348 FAX: 618-993-5960 SALES: 800-851-8180

www.southern-pride.com sales@sopride.com service@sopride.com

SERVICE: 800-437-2679 SERVICE FAX: 618-993-0378 parts@sopride.com

**\*\*\* CONGRATULATIONS \*\*\***

In selecting **SOUTHERN PRIDE** you have chosen the finest, most advanced, and fully automatic smoker / oven available. With us, "It's A Matter Of Pride".

Please read this INSTRUCTION MANUAL carefully prior to installation and operation. Proper installation, operation, and cleaning are essential for your satisfaction and safe operation.

**KEEP THIS MANUAL FOR REFERENCE**

**TABLE OF CONTENTS**

	Page
Safety Information .....	2
Oven Controls & Features .....	3
Operating Instructions .....	5
Cleaning Instructions .....	6
Digital Controler Programing .....	7
Electrical Instructions .....	9
SC-100 Wiring Diagrams .....	10
SC-200 Wiring Diagrams .....	11
Installation Instructions .....	12
Parts List .....	13
Warranty .....	15

## **SAFETY INFORMATION**

1. Be sure all untrained employees, who may operate this oven, are instructed on the proper operation and safety information prior to working with this oven.
2. Oven surfaces are **HOT** when oven is in operation. Proper utensils and protective gear should be used with this appliance.
3. Oven cleaners can be **HAZARDOUS**. Read and follow all labeled instructions.
4. The frame of the oven **MUST** be electrically grounded at all times. See “Electrical Instructions” in this manual. **FAILURE TO GROUND THIS UNIT MAY RESULT IN AN ELECTRICAL SHOCK.**
5. Do not remove the service compartment access panel unless power to the oven is **OFF**.
6. Do not allow unqualified personnel to perform service work. To do so will **VOID WARRANTY** and could be hazardous.
7. **CAUTION:** Ashes removed from ovens equipped with smoker should be extinguished immediately with water.
8. Daily cleaning is extremely important to insure **FIRE SAFETY** and **FOOD SAFETY**.

## OVEN CONTROLS & FEATURES

1. **Control Thermostat on Manual Models** - Adjustable temperature setting (100-325° F) with off position. Maintains the desired oven temperature by controlling the main heat element.
2. **Main Power Switch on Manual Models** - (red lamp) Activates the convection fan and supplies power for the control thermostat.
3. **Smoker Switch on Manual Models** - (amber lamp) Activates the smoker element. The smoker switch can activate the smoker even if the main power switch is off, allowing the operator the option to cold smoke product.
4. **Digital Roast & Hold Control** - Programmable (325 degrees F) with off position. Maintains the desired oven temperature by controlling the main heat element, convection fan and smoker element.
5. **Drip Pan** - Slides out on rails located under the oven, should be emptied after each cooking.
6. **Flue Damper (SC-200 Only)** - Has an adjustable slide which allows the operator to regulate the amount of smoke retained in the oven.
7. **Control Panel Cover** - Houses the SC-200 convection fan motor and all electrical components.
8. **Food Racks** - SC-200 has 5- 18” x 26” while the SC-100 has 4 - 17 x 17 3/4” nickel chrome plated wire food racks that slide out for easy loading and unloading of product.
9. **Casters** - For ease of moving the oven, the front casters are locking.
10. **Side Channels (SC-200 Only)** - Acts as an air channel to direct air flow in the oven, and has the slides for the food racks. Easily removable for cleaning.
11. **Smoker Chip Box** - Load with wood chips to smoke product. To fill or empty the box, slide it off of the element bracket.
12. **Blower Wheel & Fan Shroud (SC-200 Only)** - Main element and blower wheel cover can be removed for cleaning. Blower wheel located behind the fan shroud, circulates heat and smoke inside the oven.

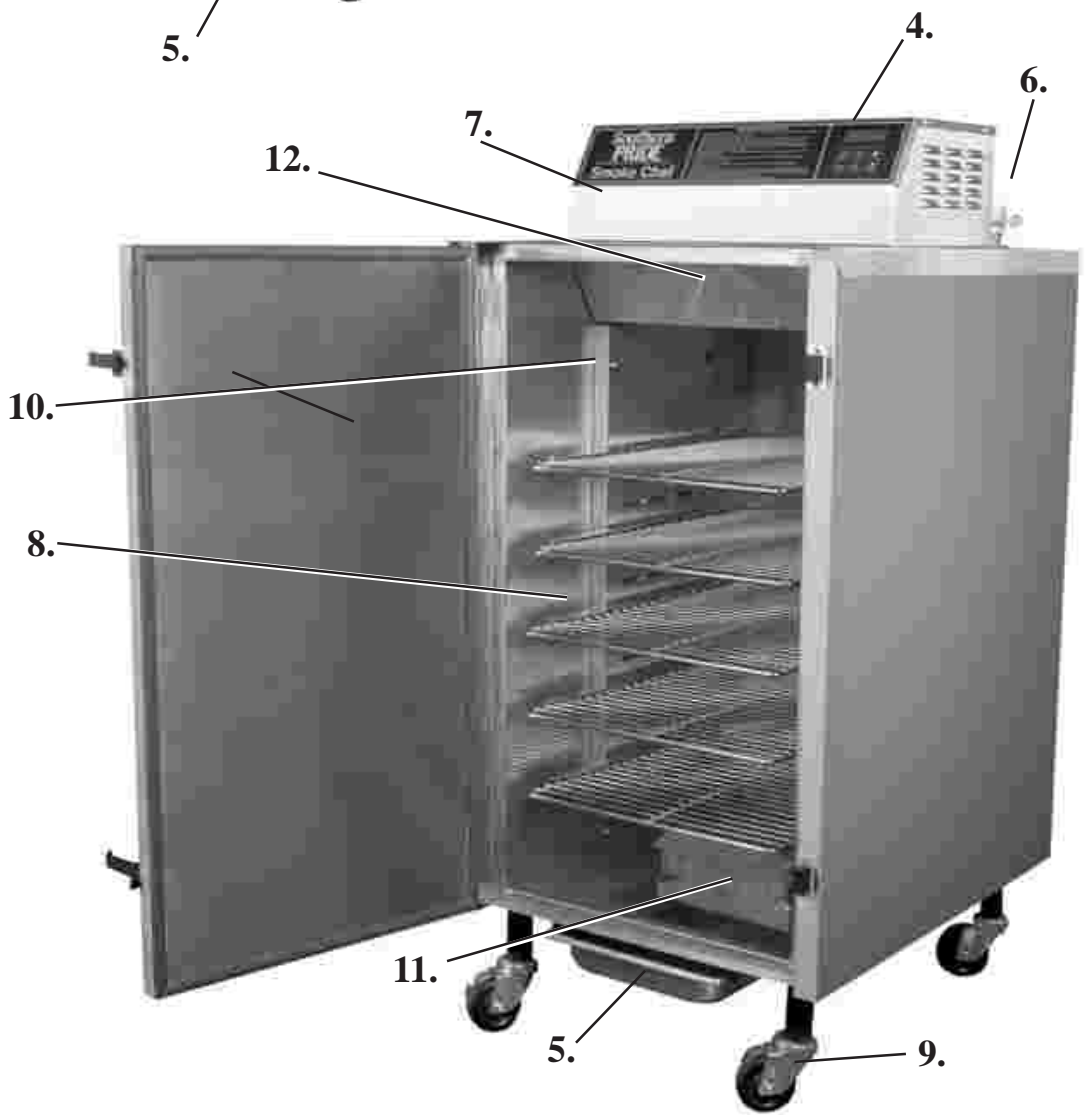
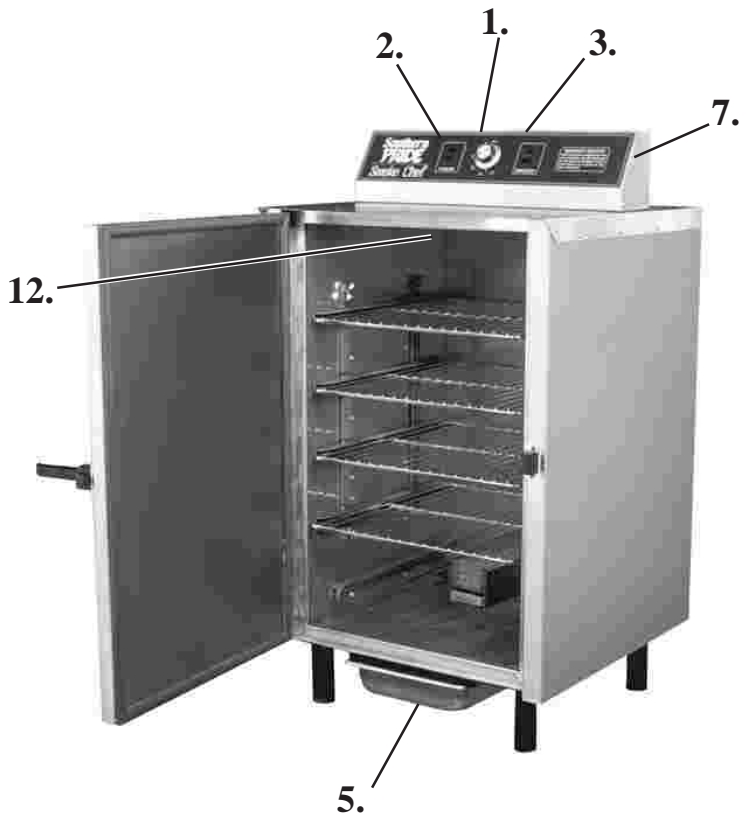

# OPERATING INSTRUCTIONS

**WARNING - The element cover and both side channels must be in place before loading or operating all of the Smoke Chef ovens!**

## **Loading the product:**

1. The SC-100-SM oven is equipped with “four”- 17” x 17 3/4” food racks for the loading of food products. The SC-200-SM convection oven is equipped with “five”- 18” x 26” food racks for the loading of food products.

The racks slide in and out for easy loading and unloading. Sheet pans may be used instead of the food racks in the SC-200-SM.

Lay the product directly on the food racks. Flat items such as ribs, pork chops, half chickens, etc. can be loaded on each shelf. Larger items, depending on size, may require the removal of every other food rack.

2. The drip pan should be emptied and slid into place under the oven. If the drip pan is not in place, grease will drip onto the floor under the oven.

## **If the product is to be smoked:**

3. Slide the chip box off the element bracket, ( **CAUTION:** This box is **HOT** when the oven has been in operation ) load wood chips in the box, **close** the lid and slide the box onto the element bracket. **Note:** The flavor and amount of smoke generated can vary with the type and amount of hardwood chips used.

## **To start cook cycle:**

4. Adjust the flue damper in the SC-200-SM (attached to the outlet of the flue pipe, located on the top right back corner of the oven). This will control the amount of smoke retained in the oven. Closing the damper will increase the amount of smoke retained in the oven; opening it will decrease the amount of smoke.

5. **Manual Controls:** Turn the main power switch on, set the control thermostat to the desired cooking temperature, and turn the smoker switch on.

**Digital Controls:** See Digital Control Operations on Page 8.

## **When cook cycle is complete:**

6. **Manual Controls:** If the product is to be held in the oven, turn the control thermostat down to the desired hold temperature and turn “off” the smoker switch. The oven will hold the product at the set temperature.

**Digital Controls:** Hold cycle is pre-programed. See Digital Control Operations on Page 8.

**Note:** Open the oven door for a few minutes to get the oven down to the hold temperature quickly.

7. **Manual Controls:** If holding the product is not desired, turn off the main power and the smoker switch, remove the chip box, and extinguish the wood chips with water. Properly dispose of the ashes. (**CAUTION:** This box will be **HOT**. Use protective gear.)

**Digital Controls: Follow Manual Control procedure above.**

8. Unload the food product and dispose of the grease drippings in the drip pan.

# CLEANING INSTRUCTIONS

**Oven should be cleaned daily to remove any grease or carbon deposits.  
Poor cleaning habits can be both a food and fire hazard.**

Mild dish detergents will remove most of the grease on all the surfaces of either oven. For areas with build up that cannot be removed with soapy water, use conventional oven cleaners.

**CAUTION: Always wear protective clothing and eyewear when using oven cleaners. Read labeled directions and warnings.**

On the **SC-200-SM**, the area above heating element cover on top of the inside can be cleaned by removing the front element cover. Remove the two (2) 5/16 bolts. Let the front drop down and then pull straight out to remove.

**AFTER CLEANING, THE COVER MUST BE REINSTALLED BEFORE OPERATING OVEN.**

Clean the outside of either oven with commercial stainless steel cleaners and polishes.

**NEVER use any abrasive scrub pads on the outside of the oven.**

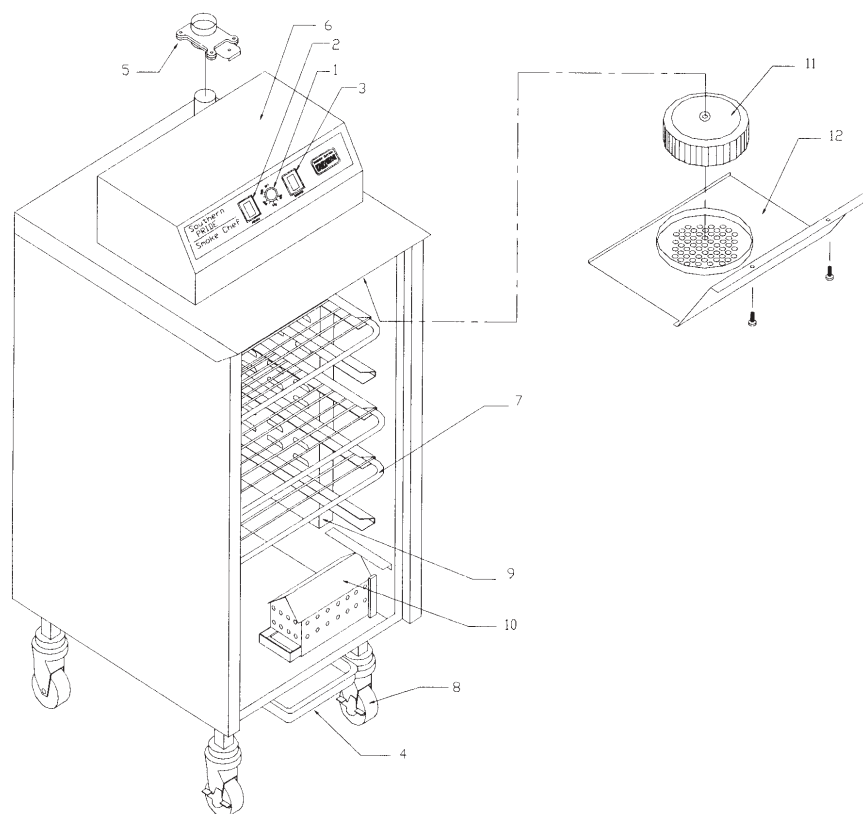

SC-200-SM with Manual Controls

# SC-200-SM DIGITAL CONTROL OPERATING INSTRUCTIONS

## To Program a menu:

The menu consists of a cook temperature, cook time, hold temperature, and CHIPS which turns the smoker on or off for the menu.

1. Control must be in the “**IDLE**” mode. If the control is “**OFF**” a press of any button will bring the control back to “**IDLE**”

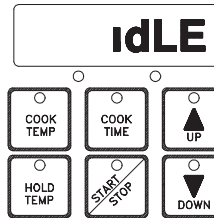

2. **PRESS** the *cook temp* button, (the actual cook temperature will appear in the display): **PRESS** the *up/down* buttons to obtain the desired cook temperature.

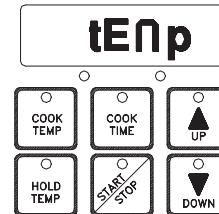

3. **PRESS** the *cook tim* button, (**tinE 1** will appear in the display): **PRESS** the *up/down* buttons to obtain the desired cook time.

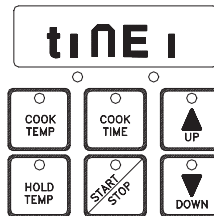

4. **PRESS** the *hold temp* button, (**HtEnP** will appear in the LED display): **PRESS** the *up/down* buttons to obtain the desired hold temp. If a hold temp is not desired: **PRESS** the *down* button until “**OFF**” is displayed in the LED.

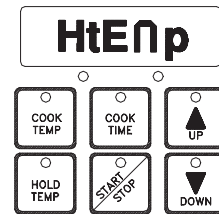

## Programming the menu is complete:

5. To start the menu, **PRESS** the *start/stop* button one time. “**CHIPS**” will appear in the LED display. Two actions are possible, a touch to the *up* button will start the menu with the wood chip smoker “**ON**” or a touch to the *down* button will start the menu with the wood chip smoker “**OFF**”. The control will begin the menu.

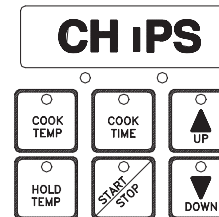

6. To pause the menu, press the *start/stop* button; to resume the menu, press the *start/stop* again.

7. To cancel or stop a menu, press and hold the *start/stop* button until “**IDLE**” shows in the LED.

## When cook cycle is complete:

8. Two actions are possible after the cook time expires. If a hold temperature was programmed into the menu, then the control will sound an audible alarm momentarily, and “**Hold**” will appear in the LED display. The length of time the control has been in the hold mode, and the word “**Hold**” will be displayed alternately in the LED display. The control will maintain the hold temperature until the *start/stop* button is depressed to “**END**” the menu, and bring the control to the “**IDLE**” mode.

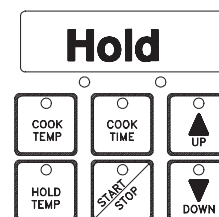

If the hold temperature was programmed to “**OFF**” then “**END**” will be displayed on the LED, and an audible alarm will sound continuously until the *start/stop* button is depressed, to end the menu, and bring the control to the “**IDLE**” mode.

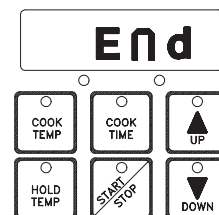



13. The control should be in the “IDLE”mode. (The main heater element, convection fan motor, and the smoker will be off).

14. If the smoker was used for the menu, remove the chip box extinguish the wood chips with water and properly dispose of the ashes, **CAUTION! This box will be HOT use protective gear.**

15. Unload the food product and properly dispose of the grease drippings in the drip pan.

16. When the control has been in the “IDLE”mode for five minutes, without a touch to any button, it will go to “OFF”. A press of any button will bring the control back to “IDLE”

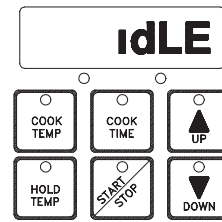

## OPERATING A SC-200-SM DIGITAL CONTROL WITH MEAT PROBE

This oven is programmed to cook one of two ways.

1. **Timed Cook** Cook to a set oven temperature using time to control the length of the cook cycle.
2. **Internal Temperature of Product -Cook** with a set oven temperature until the internal temperature of the product reaches the temperature that the meat probe is set for.

To choose to cook by *time* the control has to be set **P-off**

1. With the control in *idle* press the **up** button, the display will read either **P-on** or **P-off**, one press of the **up** button will change the setting, choose **P-off**

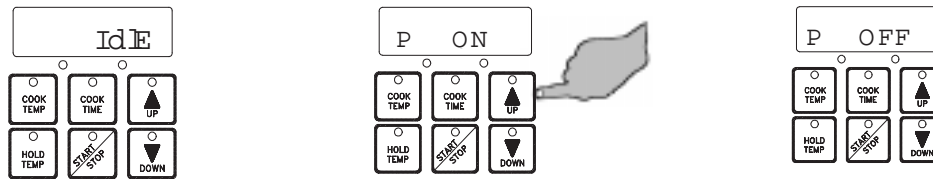

2. There is a three second pause until the control returns to *idle* and then a menu can be programmed.

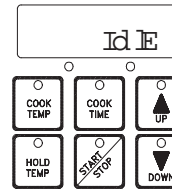

3. Use the instructions on the control panel of the Smoke Chef to program a menu.

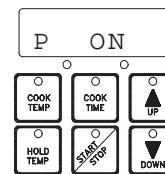

To choose to cook to an internal product temperature using the meat probe the control has to be set **P-on**

1. With the control in *idle* press the **up** button, the display will read either **P-on** or **P-off** on press of the **up** button will change the setting, choose **P-on**

2. There is a three second pause until the control returns to *idle* and then a menu can be programmed.

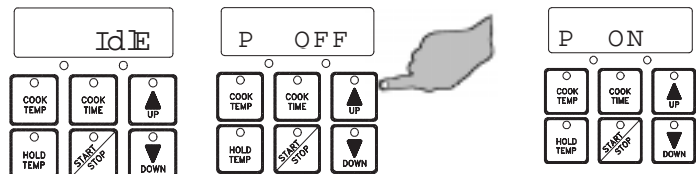

3. Make sure the meat probe is plugged into the socket inside the oven and then insert the probe into the meat. The tip of the probe should be down into the thicker part of the meat and make sure it isn't against a bone.

4. Use the instructions on the control panel of the Smoke Chef to program a menu. The **cook time** button will now be used to select the **temperature** that the **meat probe** will cook the product to.

## ELECTRICAL

### **SC-100-SM**

120 Volts AC  
60 Hz  
Single Phase  
20 AMP wiring required

### **SC-200-SM**

120/208 or 120/240 Volts AC  
60 Hz  
Single Phase  
30 AMP wiring required

**NOTE: MAKE SURE THE SUPPLY POWER CORRESPONDS WITH VOLTAGE SPECIFIED ON THE NAMEPLATE OF YOUR OVEN.**

**WARNING: CHASSIS MUST BE GROUNDED TO PREVENT POSSIBLE SHOCK HAZARD.**

**WARRANTY IS VOID IF THE OVEN IS CONNECTED TO ANY VOLTAGE OTHER THAN THOSE SPECIFIED ABOVE.**

## ELECTRICAL INSTRUCTIONS

1. The **SC-100-SM** is shipped with a plug and wire suitable for a 20 amp hookup.
2. The **SC-200-SM** is shipped with no wire and plug due to variants in 208/240 volt plugs. Your electrician must provide 10 AWG stranded four wire cable and appropriate plug for hookup in your situation.
3. Power must be OFF during installation of the SC-200 wire and plug.
4. Electrical service is provided at the terminal block on the SC-200, located behind the access panel which is in the lower left corner of the back of the oven.
5. After connecting the proper electrical service, test the voltage at the terminal block with a voltmeter.
6. If power is correct, replace the access panel and power up the oven.

# SC-100-SM Manual Wiring Diagram

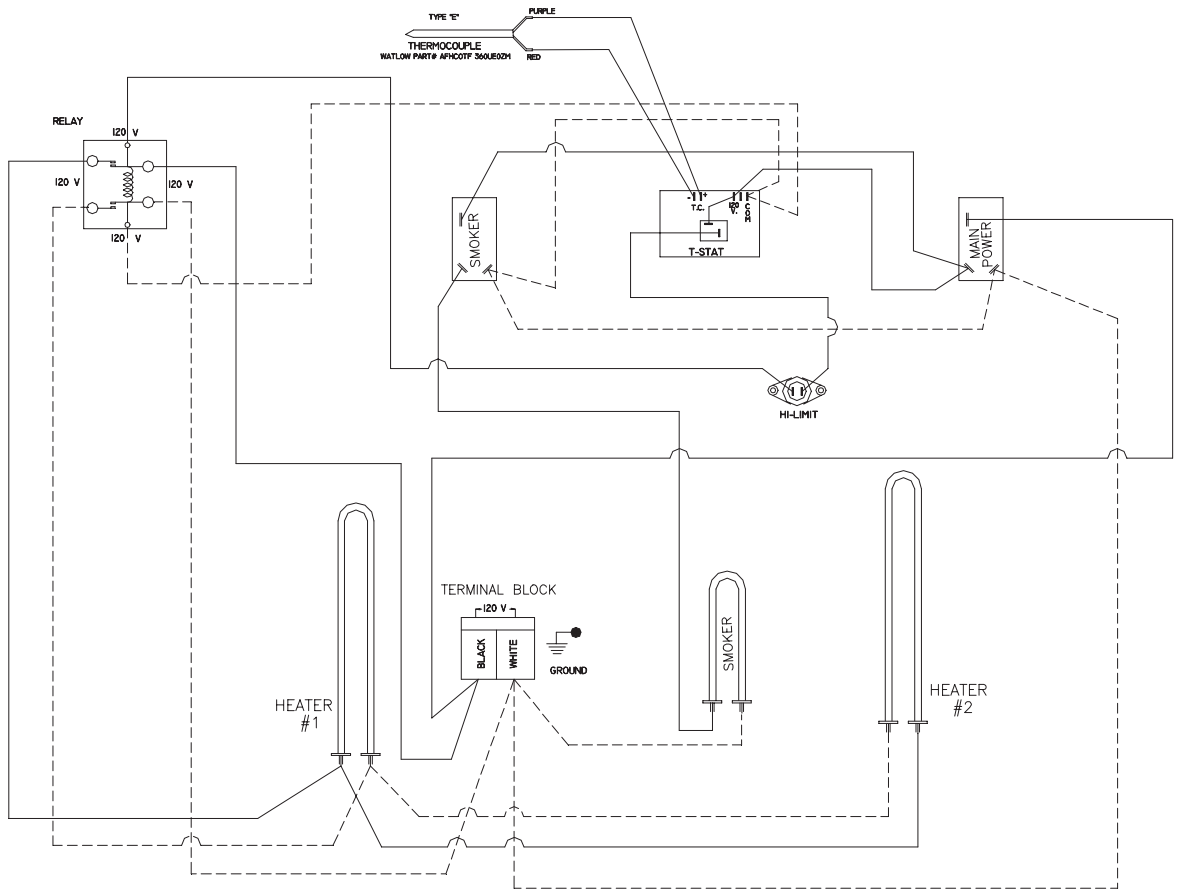

# SC-200-SM Manual Wiring Diagram

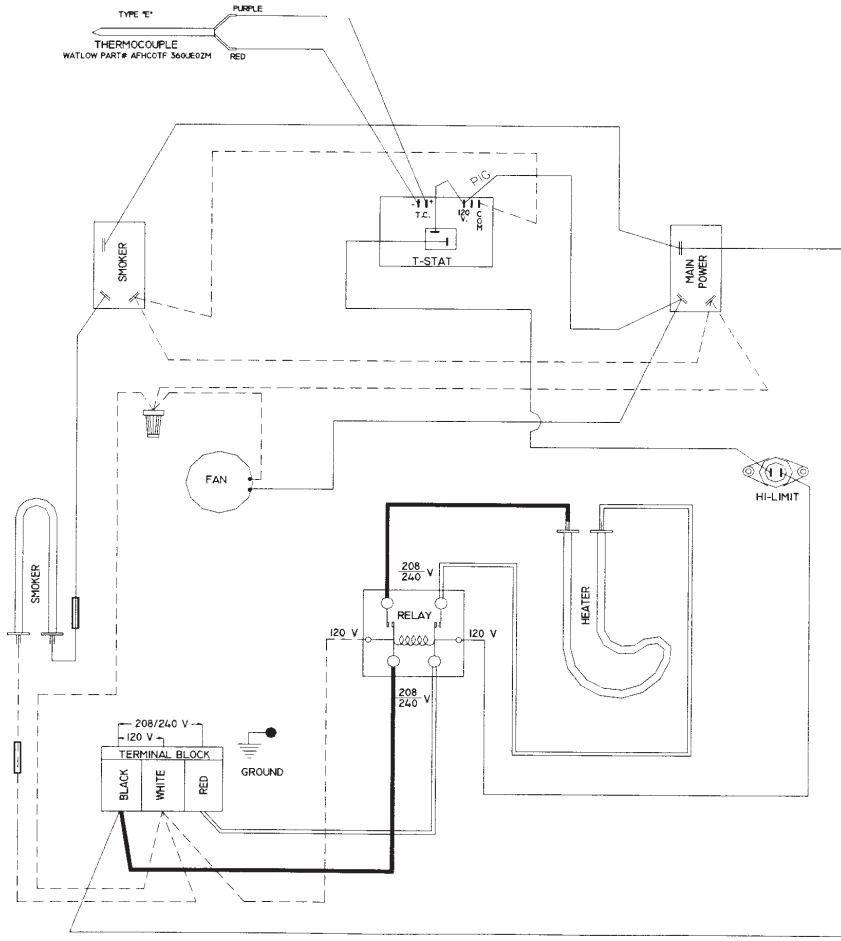

# SC-200-SM Digital Wiring Diagram

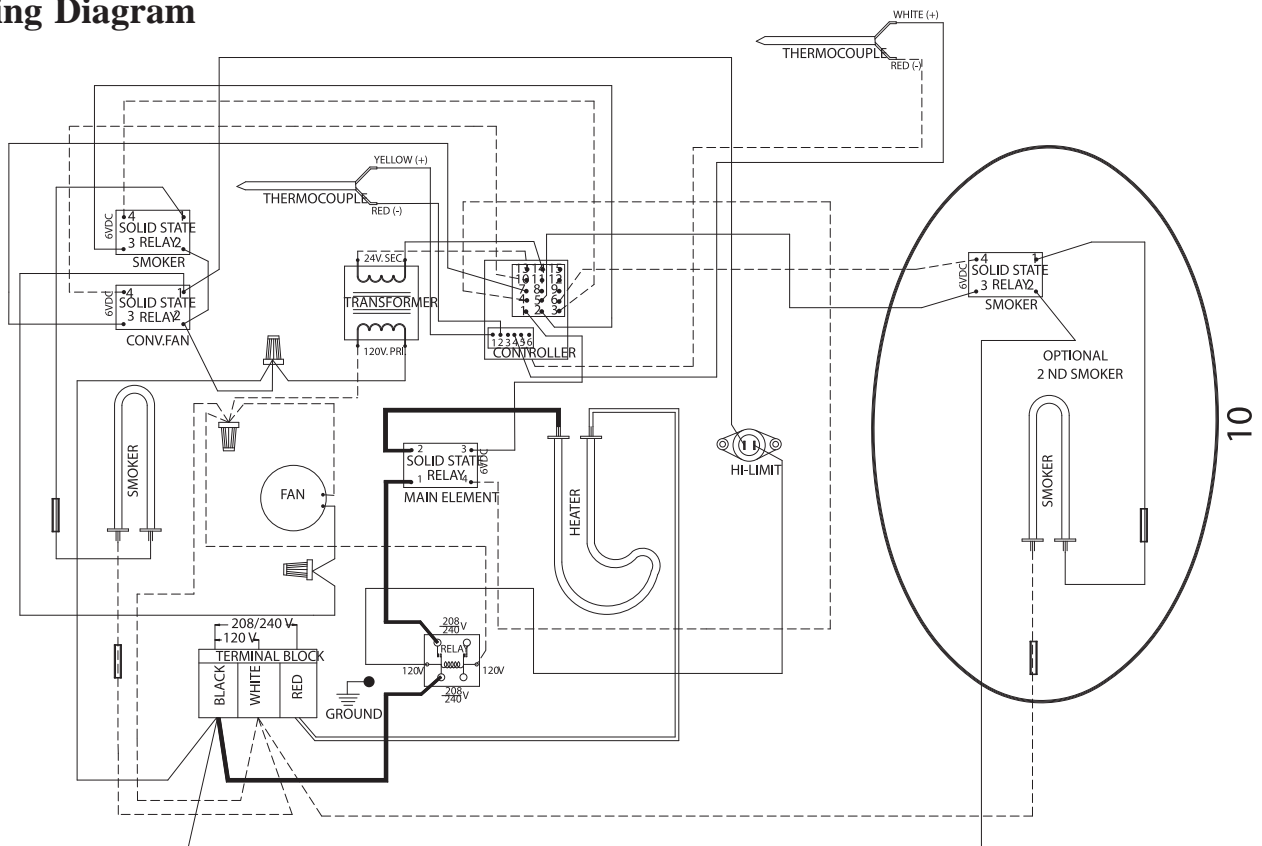

## INSTALLATION INSTRUCTIONS

1. Read and follow the electrical requirements on the previous page to insure proper connection of the oven.
2. While this oven is in operation, it will emit smoke from the vent stack or from the meat door opening if it is opened. Adequate space should be allowed for this oven under a hood to insure that the hood will capture the smoke.
3. Venting for the SC-100-SM and the SC-200-SM must be with an exhaust ventilation system in accordance with the National Fire Protection Association standard, NFPA 96. Local codes may supercede this recommendation. Check local building codes prior to installation.

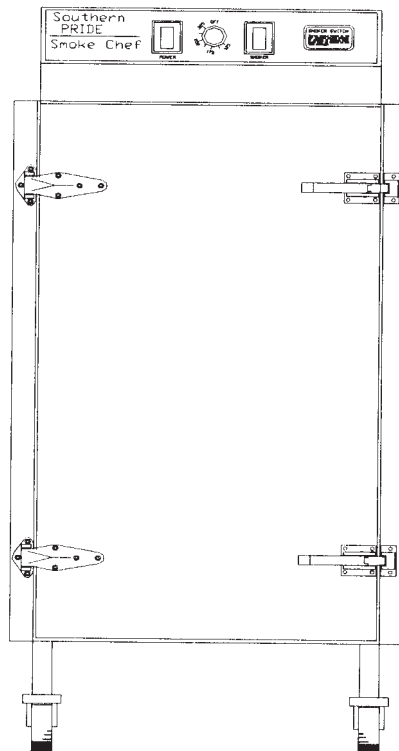

## PARTS LIST

1. 1046 SC-200 - 240 VOLT MAIN HEATING ELEMENT  
1046-1 SC-200 - 208 VOLT MAIN HEATING ELEMENT  
1066 SC-100 - MAIN ELEMENT ( Two Required)
2. 2173 FLUE DAMPER
3. 2422S SC-200 - SMOKE CHEF BLOWER WHEEL
4. 1040SC SC-200 - CONVECTION FAN MOTOR
5. 2417 SC-200 - 6" COOLING FAN BLADE
6. 1090E (OPTIONAL) 100-325 DEGREE DIGITAL CONTROL
7. 1098 (OPTIONAL) S.S. THERMOCOUPLE FOR DIGITAL CONTROL
8. 1259-2 THERMOSTAT CONTROL KNOB
9. 1006 STANDARD, CONTROL THERMOSTAT
10. 9172 340 DEGREE HIGH LIMIT SWITCH
11. 0573 MAIN POWER SWITCH (Manual Control Only)
12. 0574 SMOKER SWITCH (Manual Control Only)
13. 1045 CONTACTOR, FOR MAIN ELEMENT
14. 1008 SC-100 - TERMINAL BLOCK  
1010 SC-200 - TERMINAL BLOCK
15. 2116 DOOR HINGE
16. 2438 DOOR LATCH AND CATCH
17. 1049 300 WATT SMOKER ELEMENT
18. 4178 SC-100 - MEAT DOOR GASKET  
4179 SC-200 - MEAT DOOR GASKET  
4179G SC-200 - NEW MEAT DOOR GASKET (Around Door Opening)

PARTS LIST

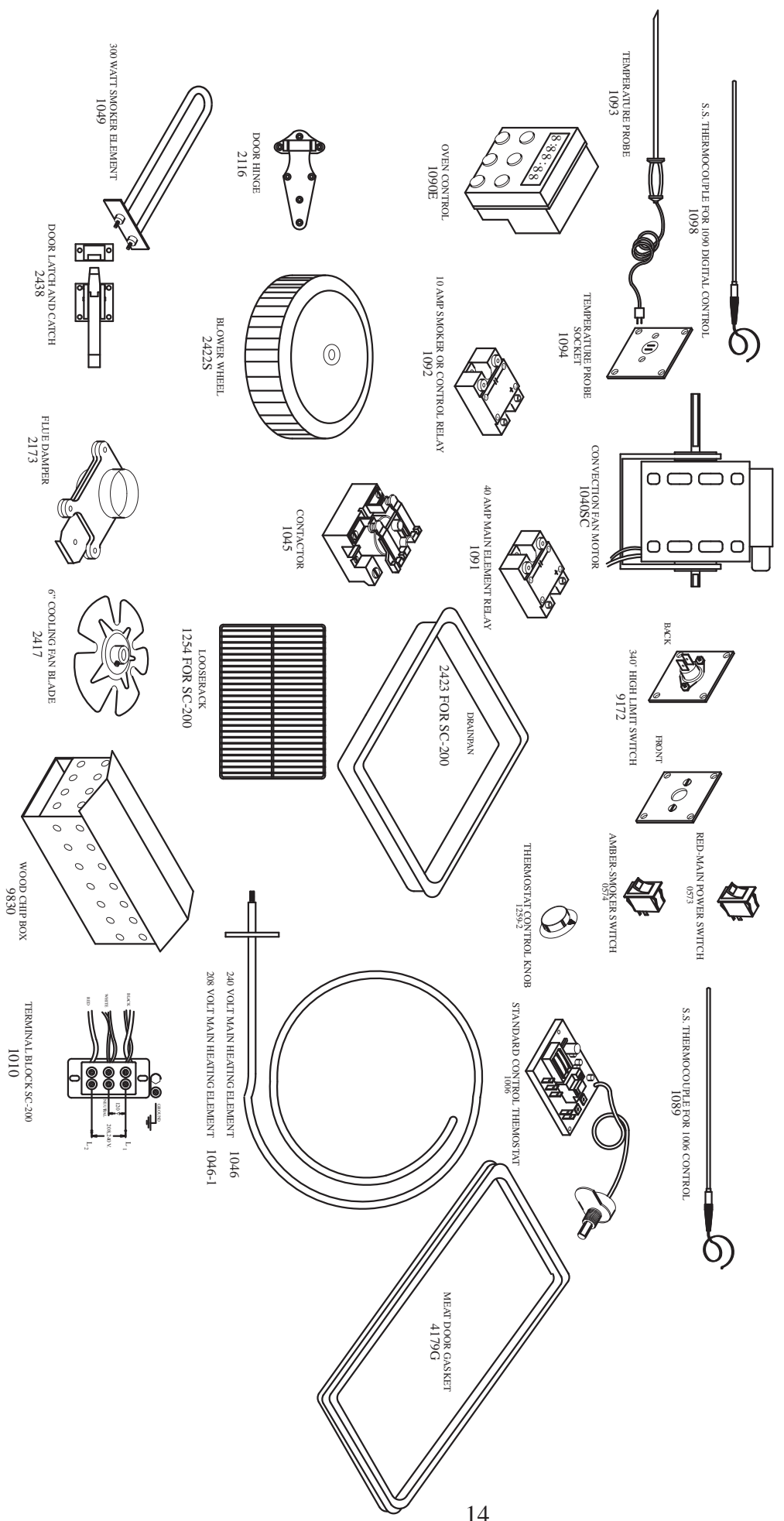

**ONE YEAR LIMITED WARRANTY  
(CONSULT FACTORY FOR DETAILS)  
90 DAY LABOR WARRANTY (PRE AUTHORIZED)**

Southern Pride guarantees all new equipment of its manufacture to be free of defects in material and factory workmanship for a period of one year provided that the equipment is installed in the Continental United States, Alaska, or Hawaii and operated according to the Owner's Manual while located at the original address of installation, the warranty registration card has been completed and returned to the factory within fifteen (15) days after installation and a start-up has been preformed by an authorized service agent.

Southern Pride's obligation under this warranty is limited to one of the following options with the option applicable to be selected by Southern Pride at the sole discretion of Southern Pride.

1. Owner to return part, freight PREPAID. Southern Pride is to repair at own expense if defective, and ship part back to owner freight collect.
2. Southern Pride to furnish replacement part, freight collect, without requesting return of the defective part.
3. Southern Pride to furnish replacement part, freight collect, in exchange for return of the defective part, freight collect.

Under certain circumstances Southern Pride will reimburse owner for limited labor costs in replacing parts during a period of not more than ninety (90) days after installation, **(provided that work is prior authorized and confirmed by Southern Pride's Service Manager.)**

Because Southern Pride does not and cannot control the owner's installation, use and maintenance of equipment manufactured by Southern Pride, this warranty does not cover: any equipment installed improperly; any equipment calibrated after start-up and acceptance; any component disassembled in the field; damaged due to improper cleaning, i.e. burner (hosing or "watering down" machines will cause electrical failures not covered by warranty); blown fuses, light bulbs, gaskets, electric elements and accessory components not installed or manufactured by Southern Pride. Shipping damage must be reported to the carrier and is not covered under this warranty.

Southern Pride will not be liable for damage as a result of improper installation, misuse, abuse, alteration of original design, incorrect voltage, **unauthorized service**, or breakage of fragile items, Southern Pride will not be liable for any loss or consequential damage or expense accruing directly or indirectly from the use of equipment covered by this warranty including any production or product losses or other damages which may occur as a result of equipment malfunction or failure. This warranty does not cover cooking performance, which is a function of food types, textures, temperatures and other variables chosen by the owner and over which Southern Pride has no control. The effect of corrosion, fire and normal wear on the equipment or component parts is not covered by this warranty. This warranty does not apply to damage caused by accident or to damage caused by the negligence of the owner and the employees of the owner or to damage caused by lightning generated electrical current or any other Act of God whatsoever. This warranty does not apply to any equipment bearing a serial number which has been tampered with or altered.

This warranty is exclusive and is in lieu of all other warranties, express or implied, including any implied warranty or merchantability or fitness for particular purpose, each of which is hereby expressly disclaimed, the remedies described above are exclusive and in no event shall Southern Pride be liable for special, consequential or incidental damages for the breach or delay in performance of warranty.

**TERMS AND CONDITIONS**

For purposes of definition and interpretation, the term "Seller" as used herein refers to Southern Pride and the term "Buyer" refers to the originator of a specific purchase order to Southern Pride.

Possession of a price list does not necessarily constitute an offer to sell by Southern Pride. Prices and specifications are subject to change without notice. All items will be invoiced at prices in effect at time of shipment. Equipment prices do not include federal, state, city or local taxes which may apply and all sales are subject thereto. No order, whether written or oral, shall result in a contract, unless it is accepted and acknowledged in writing by Seller at Seller's office in Marion, Illinois.

Shipping weights are approximate and all prices are quoted F.O.B. Marion, Illinois. All "common carrier" shipped equipment shall be domestic crated; all others shall be uncrated and subject to delivery charge per zone chart. Any equipment held for shipment upon Buyer's request beyond the delivery date specified on original purchase order will be due and payable within terms and will result in storage charges.

Delivery estimates are figured from date written orders are received and accepted by Seller. Seller will meet Buyer's delivery request as nearly as possible, but does not guarantee shipment nor delivery on any particular date. Seller reserves right to ship merchandise via any responsible carrier. Seller's responsibility ceases upon acceptance by carrier. Buyer is expected to examine contents of shipments and immediately report any damage to carrier authorities.

Payment terms shall be 30% deposit with order; balance prior to delivery unless otherwise agreed in writing by Seller. Returns of any merchandise may not be made without Seller's written approval, prior to return. Seller shall impose a 20% restocking charge for handling of any returns. All cancellations must be in writing. Cancellations are also subject to a 20% fee.